



METRO ETHERNET PRODUCTS



bayanME Products

- **Metro Private Line (MPL)** – a point to point dedicated Ethernet bandwidth connectivity within the bayanME network
- **Metro LAN**
 - **Point to point** – a point to point Ethernet connectivity sharing bandwidth resources within the bayanME network
 - **Point to Multi-point** – a multiple point to point Ethernet connectivity sharing bandwidth resources within the bayanME network
 - **Multi-point to Multi-point** – any to any Ethernet bandwidth connection sharing a Transparent LAN service within the bayanME Network



bayanME Products

<u>Variant</u>	<u>MPL</u>	<u>MLAN</u>		
Connectivity	Point to point	Point to Point	Point to Multi-point	Multi-point to Multi-point
Network	SDH only	SDH and IP Network		
Bandwidth	Dedicated	Shared		
Port Speed	4,6,8,10,20,30, 40,50,60,70,80,90 100,200,300,400,500 600,700,800,900 Mb and 1 GB	4,6,8,10,20,30, 40,50,60,70,80,90 and 100 Mb		
Interface and Last-mile	<p>< 10 Mb: Electrical and Ethernet Modem</p> <p>>10Mb: Optical and SDH Access eqpt</p>			

bayanME Products

<u>Variant</u>	<u>MPL</u>	<u>MLAN</u>
Reliability	Last-mile (99.5%) SDH and IP Core Network (99.96%)	
Performance	Throughput (100%) Packet loss (1%) Max MTU Size (15000)	Throughput (70%) Packet loss (1%) Max MTU Size (15000)

bayanMPL

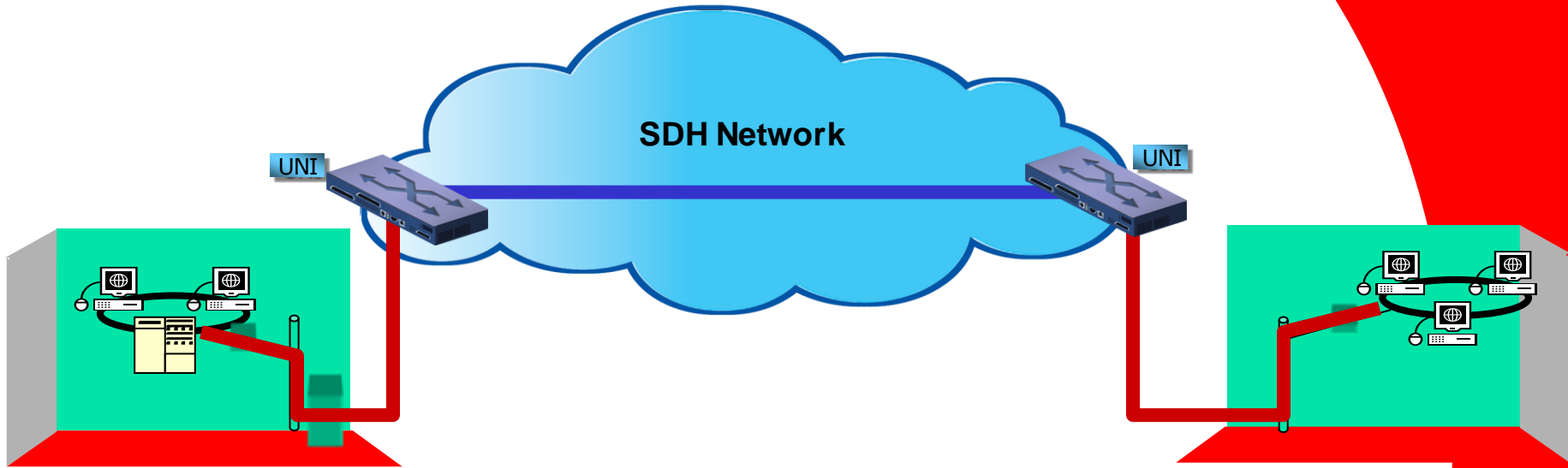

COVERAGE AREAS

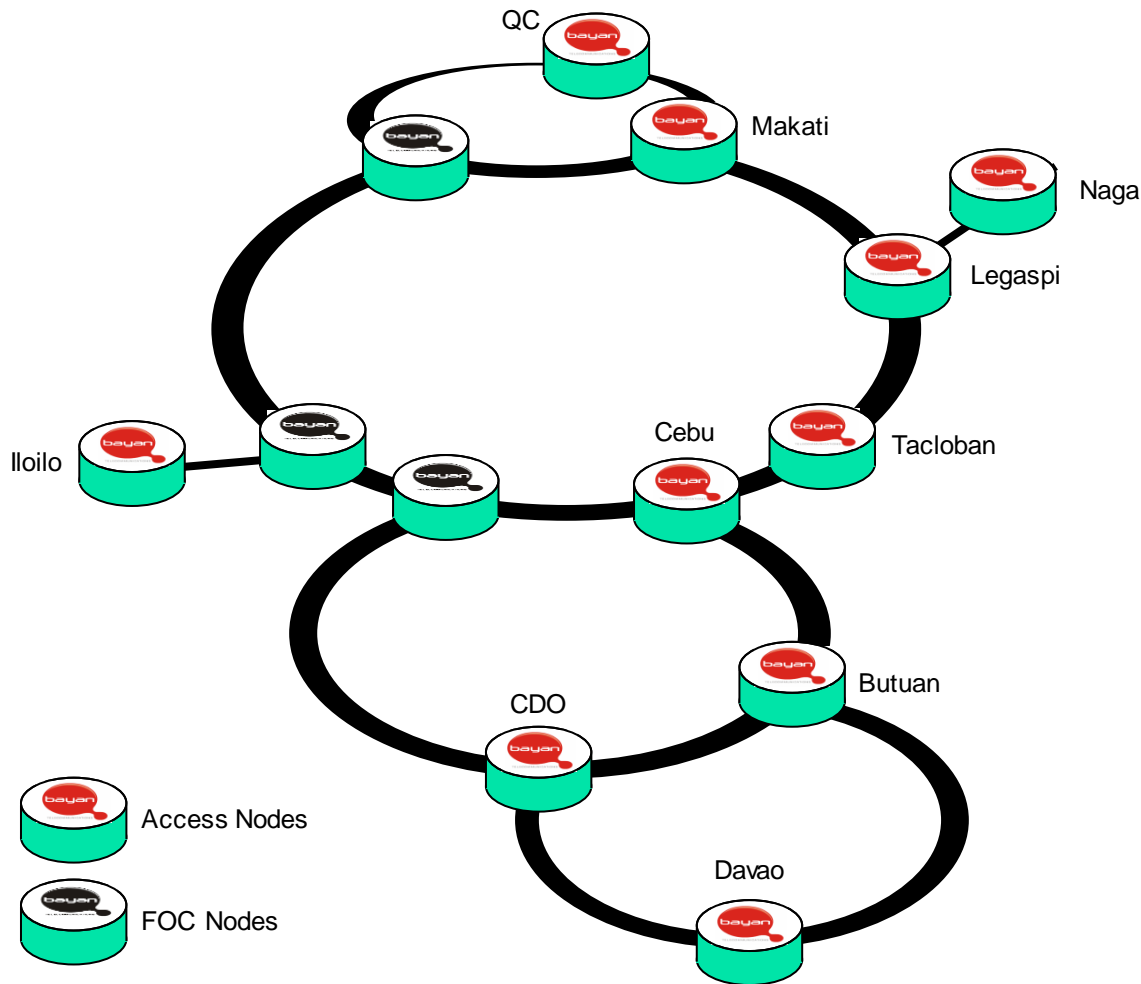

- Metro Manila
- Naga & Legaspi
- Tacloban
- Cebu
- Iloilo
- Butuan
- Cagayan de Oro
- Davao

Via bonded copper: 4, 6, 8, 10 Mbps

Via FOC: 20, 30, 40, 50, 60, 70, 80, 90, 100 Mbps



IPVPN SERVICE



The Business Advantages of a MPLS solution:

- **The Business Advantages of a MPLS solution:**

- 1) Improve Productivity**

- a. Better performance for existing applications
- b. Easier to add new applications/technologies
- c. Facilitates growing peer-to-peer paradigm
- d. Easier moves/adds/changes

- 2) Improve Protection**

- a. Eliminates public Internet security threats
- b. Supports disaster recovery

- 3) Improve Profitability**

- a. Lower Total Cost of Ownership



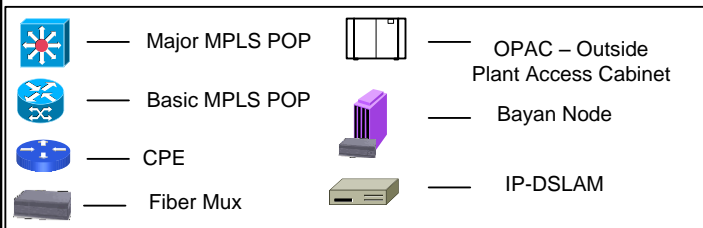
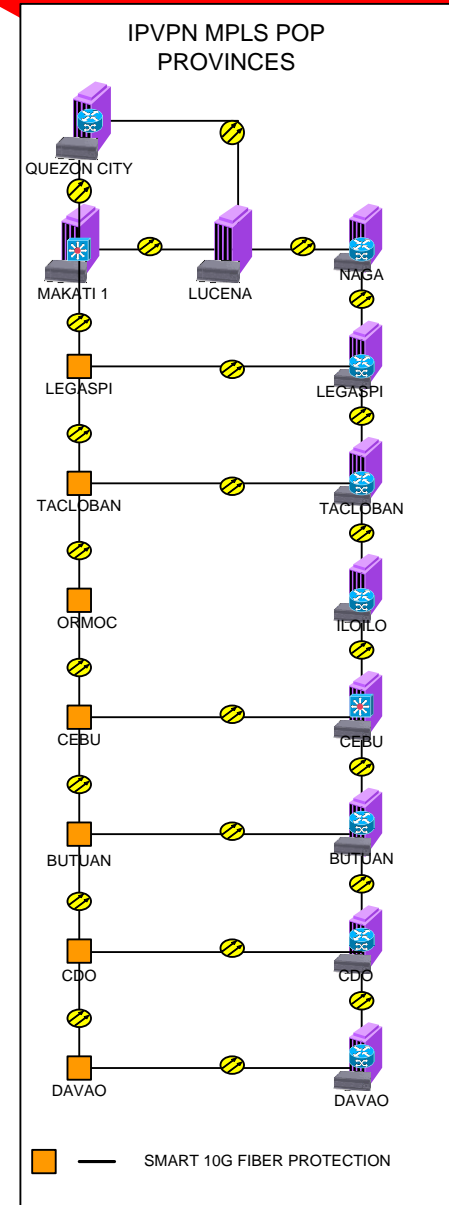
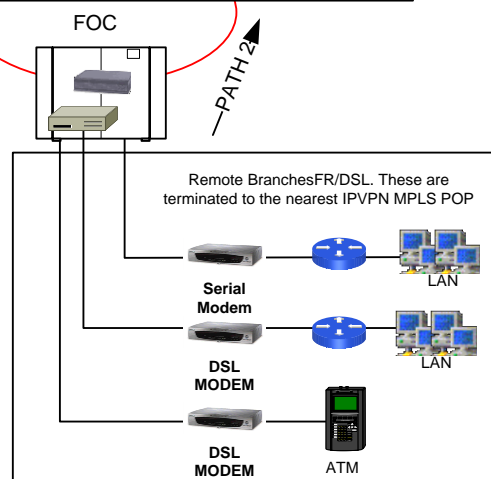
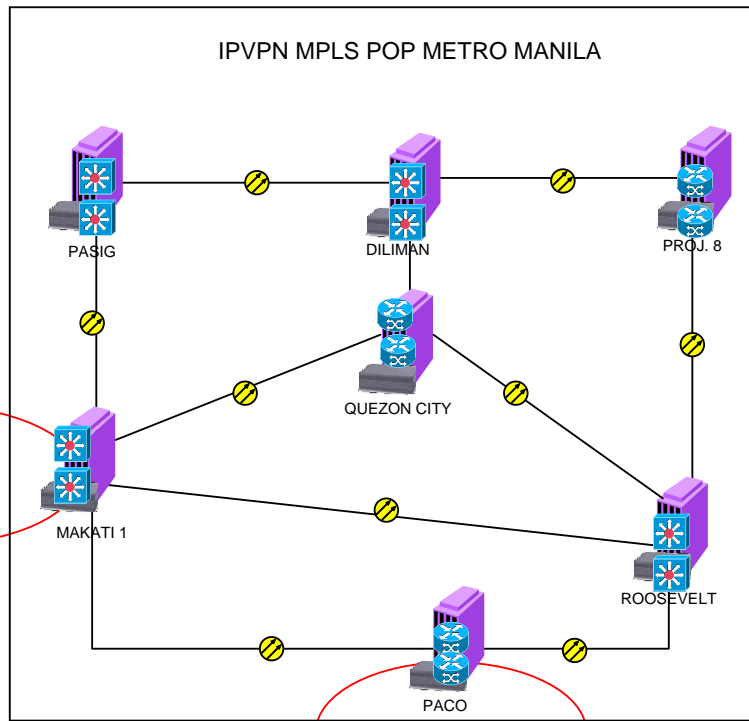
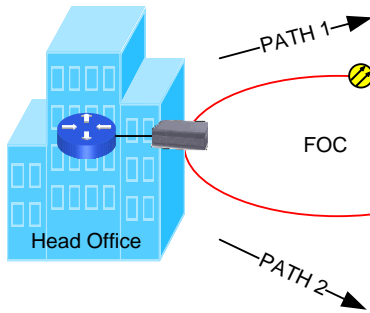

Customer Engineering
 2/F Bayantel Corporate Center, Malingap cor.
 Maginhawa Sts., Teacher's Village East,
 Diliman, Quezon City
 4492321/4972008

IPVPN MPLS

PREPARED BY:
Gerrald T. Fortea

FILENAME:

APPROVED BY:
Renato Quiambao

DATE:

AM CONCERNED:



IPVPN NETWORK

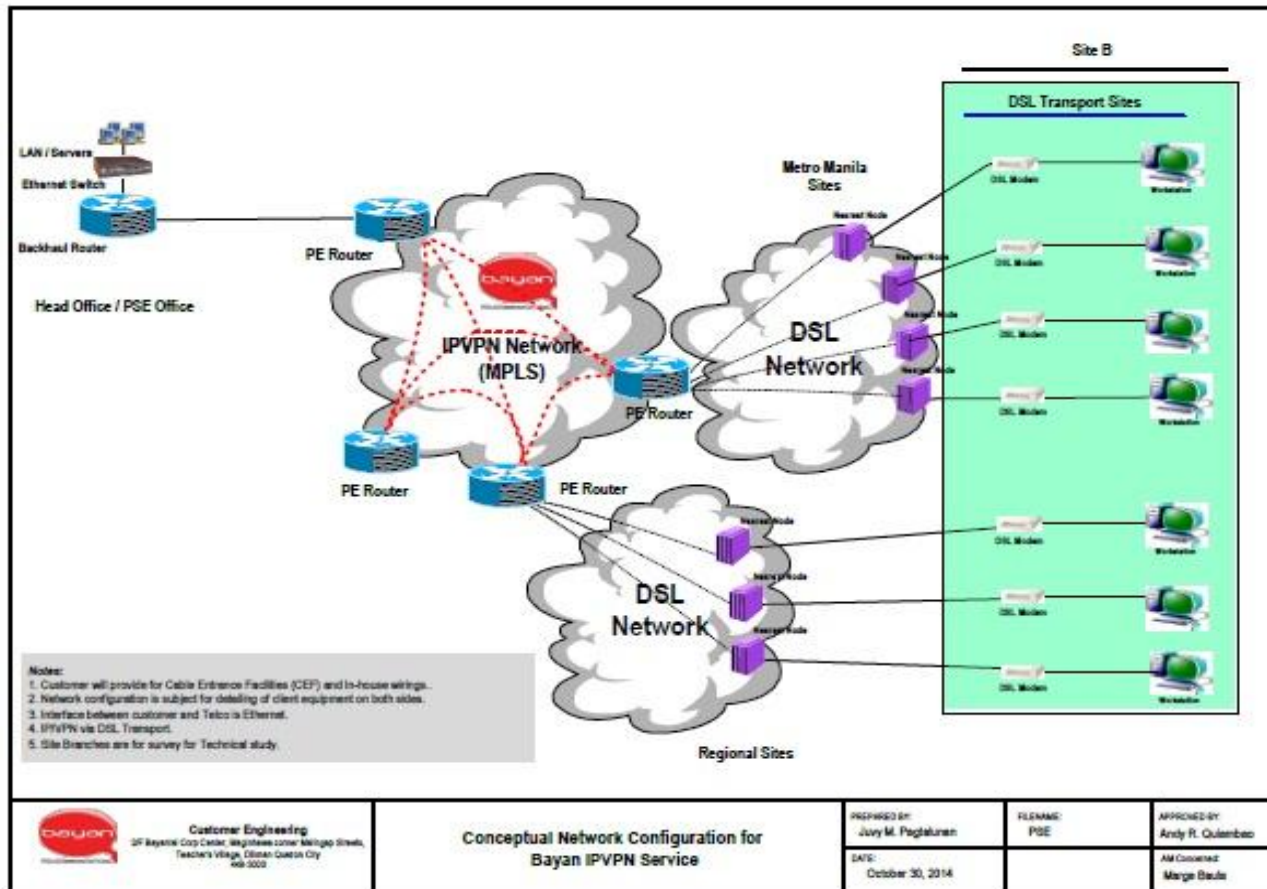

PSE BROKERS LEASED LINE REQUIREMENT : BUDGETARY COSTING

SERVICE	SPEED	MRR	OTC
DLL	2MB	18,500	3,500
DLL	1MB	11,000	3,500
SERVICE	SPEED	MRR	OTC
IPVPN	2MB	15,500	3,500
IPVPN	1MB	9,500	3,500
SERVICE	SPEED	MRR	OTC
MPL	2MB	22,500	12,500
MLAN	2MB	13,500	12,500
Note :			
For Budgetary Costing purposes			
VAT Exclusive			
Prices are available for MM area only			
Subject for actual technical Survey			

Please Contact :

**Margarita S. Baula
Account Manager
Bayan Business**

**0928-5562743 : 449-4515
|msbaula@bayan.com.ph**



End of Presentation

